

**Montageanleitung  
Tandem-Schwenkauszug  
für 60er Hochschrank**

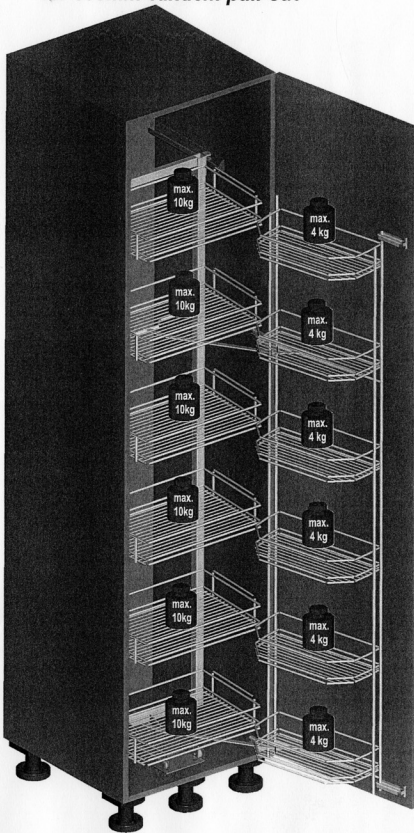

**Mounting Instruction  
for 600mm Tandem pull-out**



3x



1x



2x



2x



1x



1x



1x

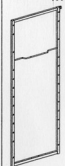

1x



2x



1



Vor dem Einbau muss der Schrank ausgerichtet und gegen Kippen gesichert werden.

*Before starting with installing, make sure that cabinet is leveled and fixed against tilting.*

1x



1x

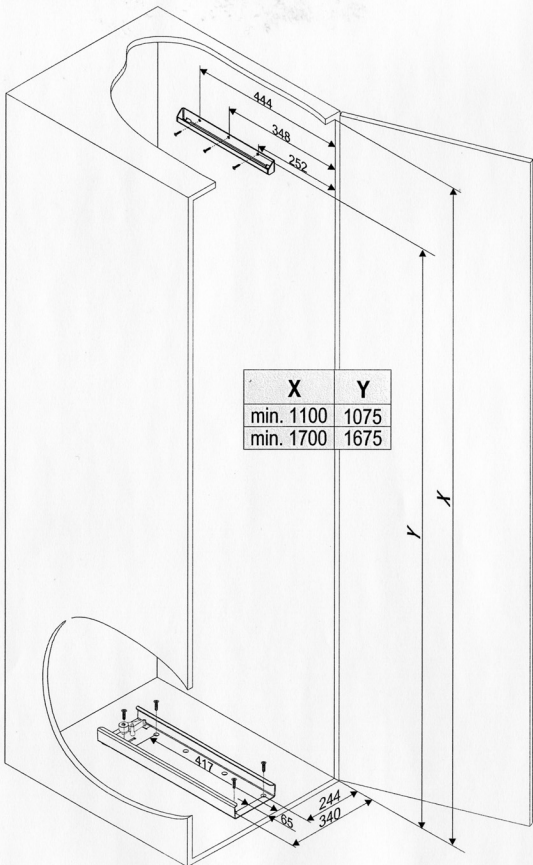

**2**
**A** Tür rechts  
Door right

3x



X	a	b
min. 1100	625	815
min. 1700	1225	1415

**Sollte auf Höhe der oberen Lager ein Türscharnier montiert sein, so ist das betroffene Lager entsprechend tiefer zu montieren**

*In case of top bearings are in same height as hinge, the bearing is to move to the next possible lower position*

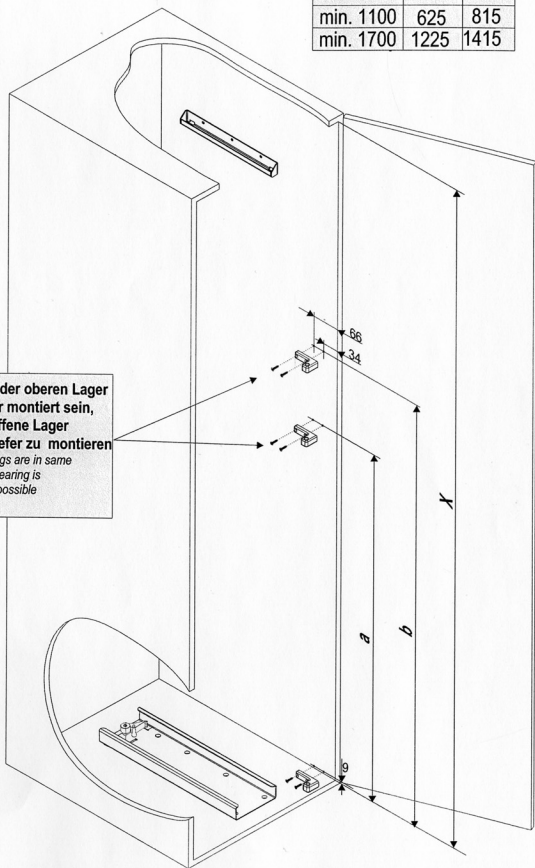

**B** Tür links  
Door left

3x



X	a	b
min. 1100	625	815
min. 1700	1225	1415

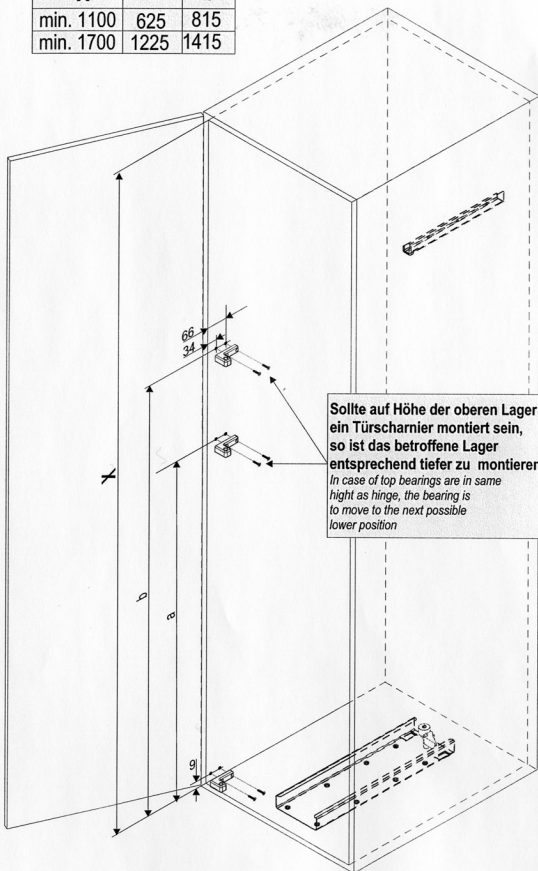

**Sollte auf Höhe der oberen Lager ein Türscharnier montiert sein, so ist das betroffene Lager entsprechend tiefer zu montieren**  
*In case of top bearings are in same height as hinge, the bearing is to move to the next possible lower position*

1x



1x



2x

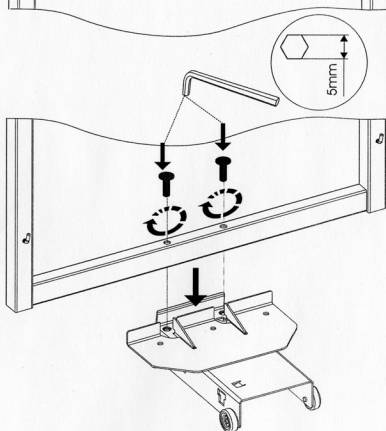
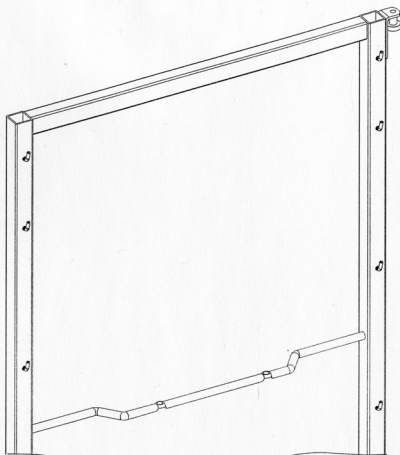

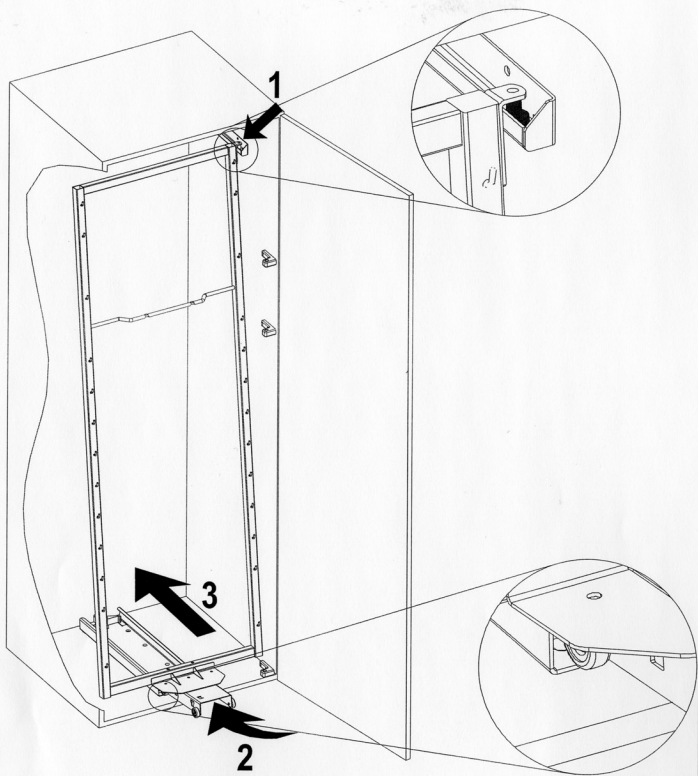

**5**

**A** Tür rechts  
Door right

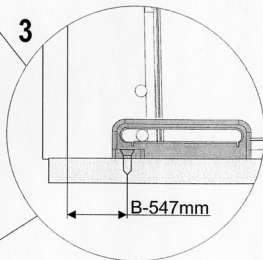
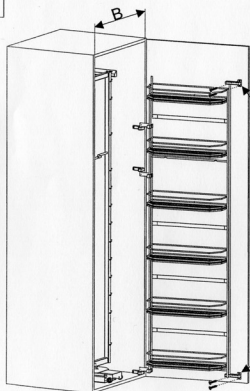
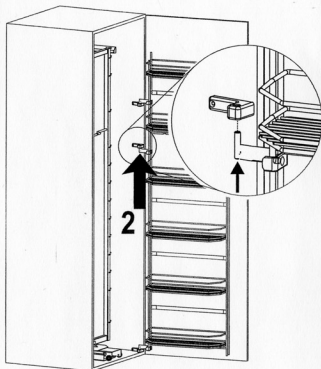
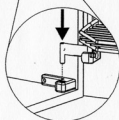
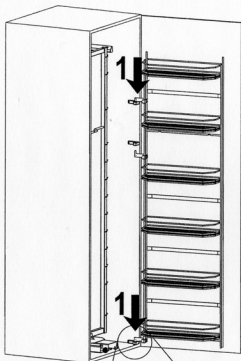

**(B)** Tür links  
Door left  
Anlieferzustand für  
rechts scharnierte Tür  
State at delivery

Links scharnierte Tür  
Door left mounted

1x

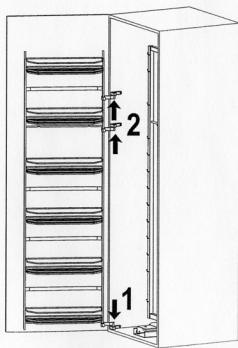
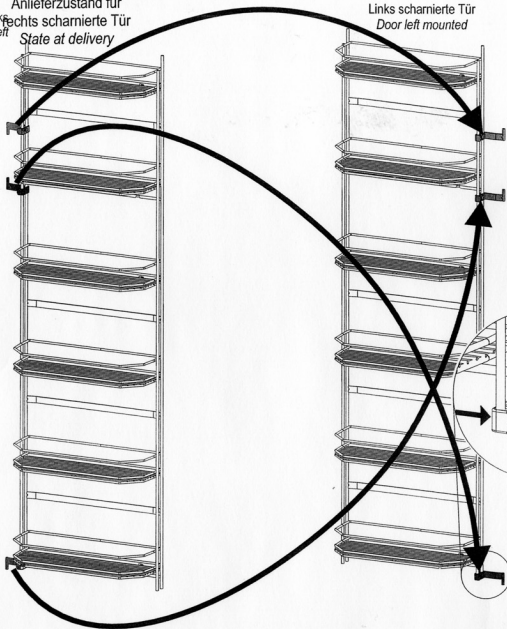

→ S. 7  
p. 7



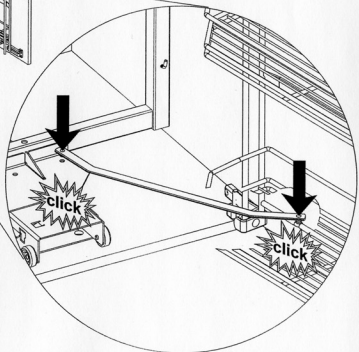
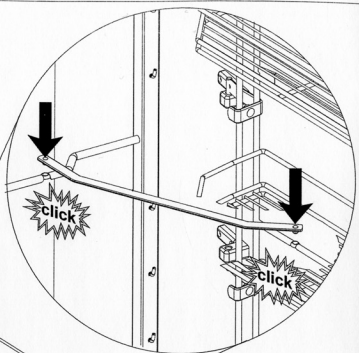
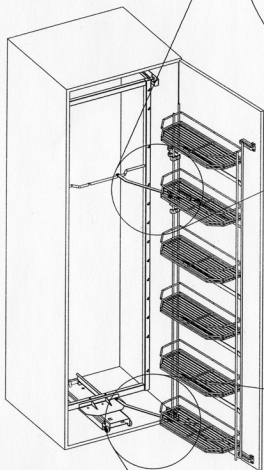

Für links schamierete Tür spiegelbildlich  
For left mounted door mirror image

## 7 Aufbau als Tandem-Depot Installation as Tandem Depot

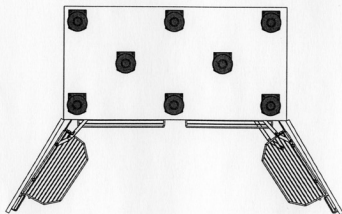
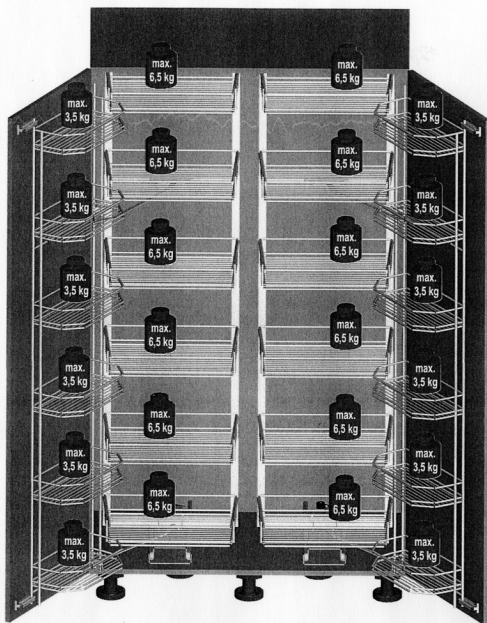

6x



2x



4x



4x



2x



2x



2x



2x



4x



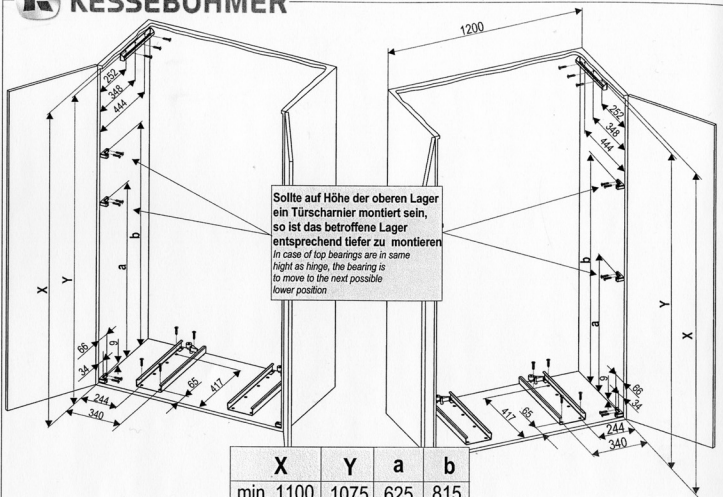

X	Y	a	b
min. 1100	1075	625	815
min. 1700	1675	1225	1415

1x



Anlieferzustand für  
rechts scharnierte Tür  
State of delivery

Links scharnierte Tür  
Door left mounted



Anlieferzustand für  
rechts scharnierte Tür  
*State at delivery*

Links scharnierte Tür  
*Door left mounted*

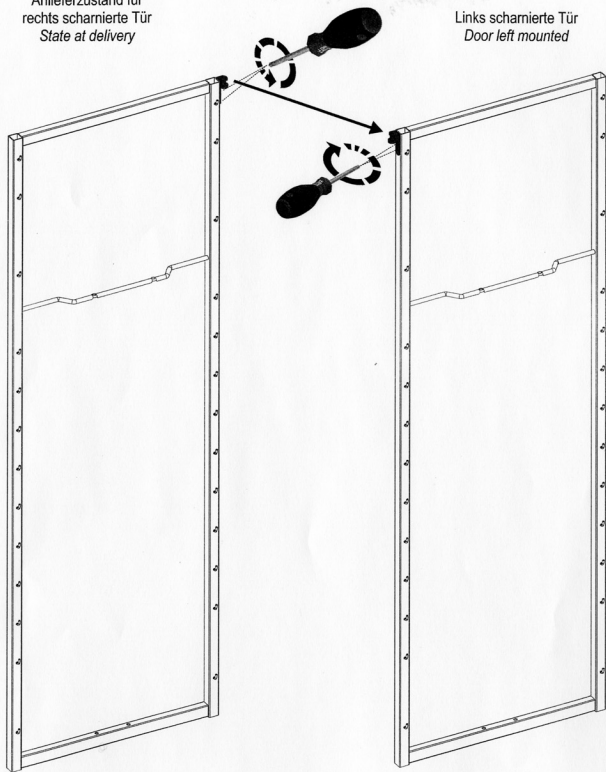

→ S. 5 - 7  
p. 5 - 7