

Montageanleitung Tandem-Schwenkauszug für 45er + 50er Hochschrank

*mounting instruction for 450 mm and 500 mm
tandem pull-out*

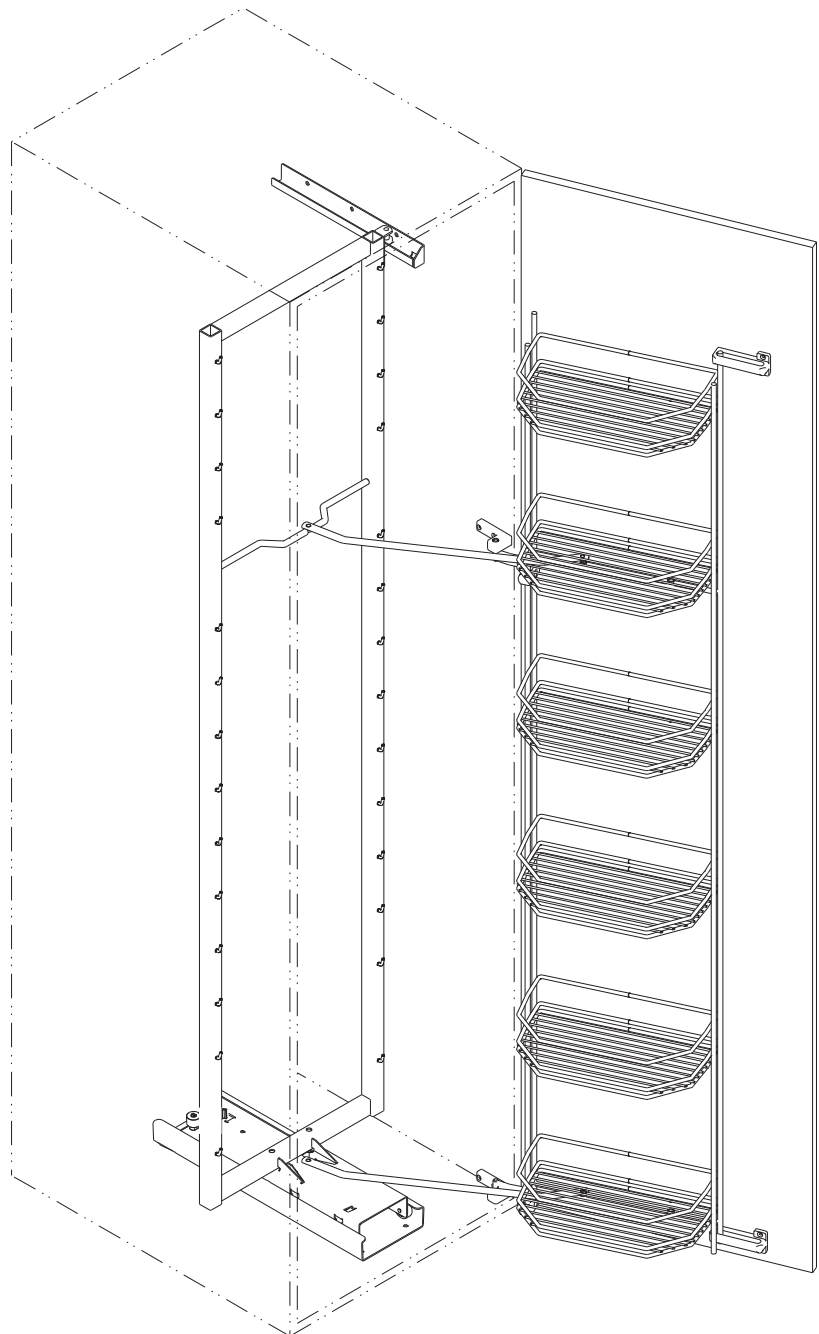

1a. Tür rechts *right hand door*

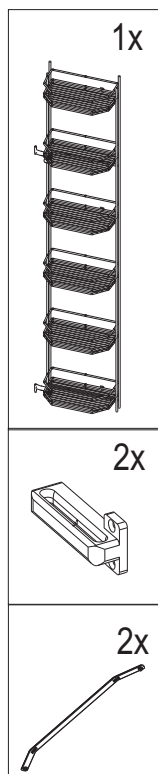
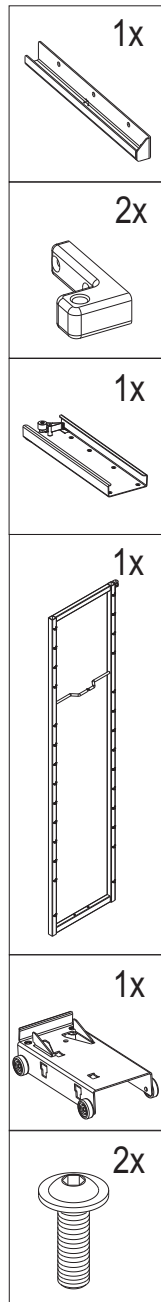
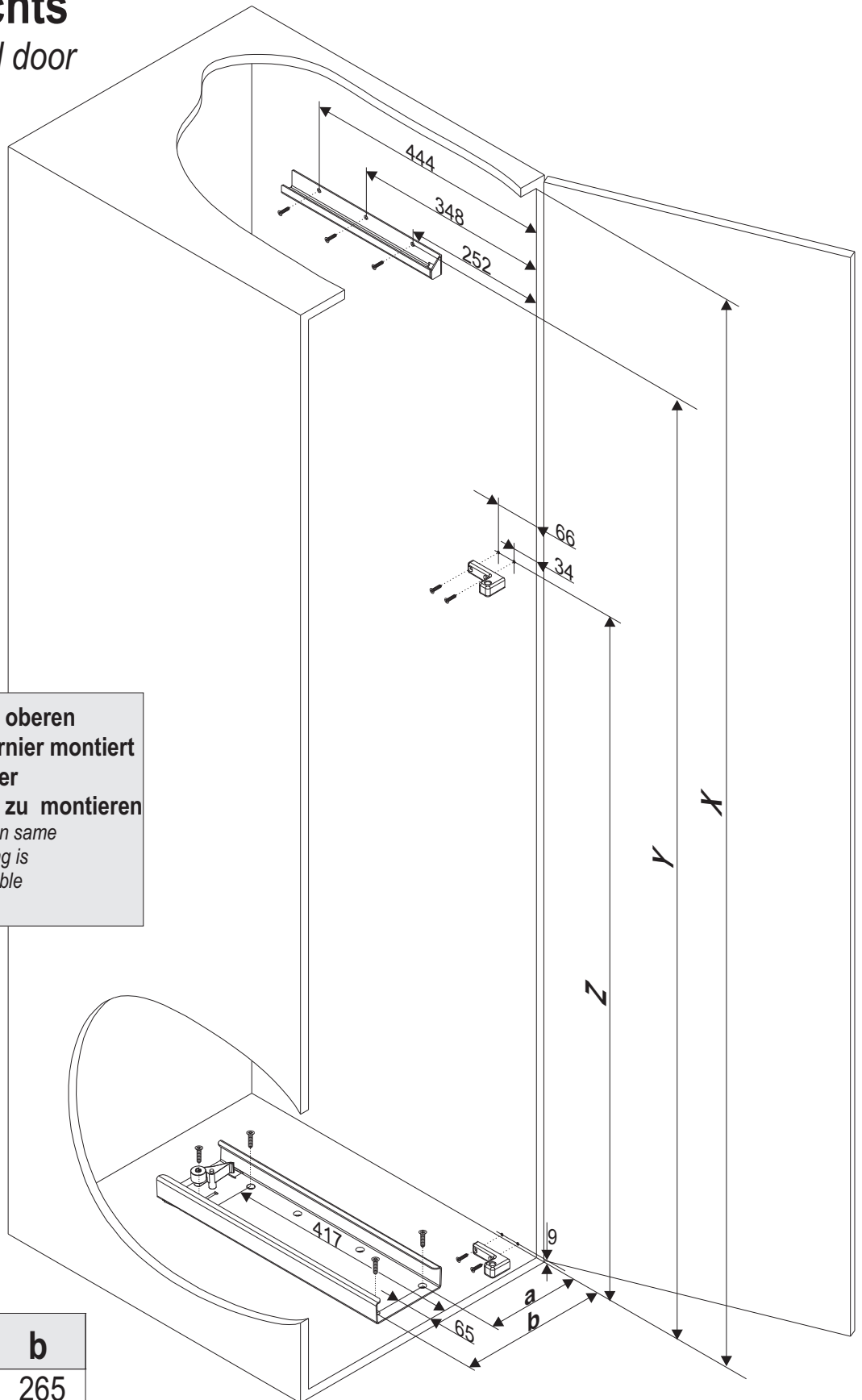
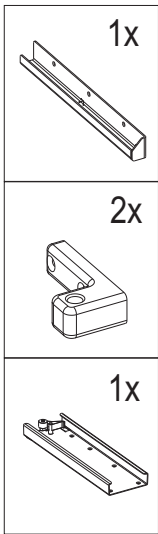

**Sollte auf Höhe des oberen
Lagers ein Türscharnier montiert
sein, so ist das Lager
entsprechend tiefer zu montieren**

*In case of top bearing is in same
hight as hinge, the bearing is
to move to the next possible
lower position*

	a	b
45er	169	265
50er	194	290

X	Y	Z
min. 1100	1075	625
min. 1700	1675	1225

1b. Tür links

left hand door

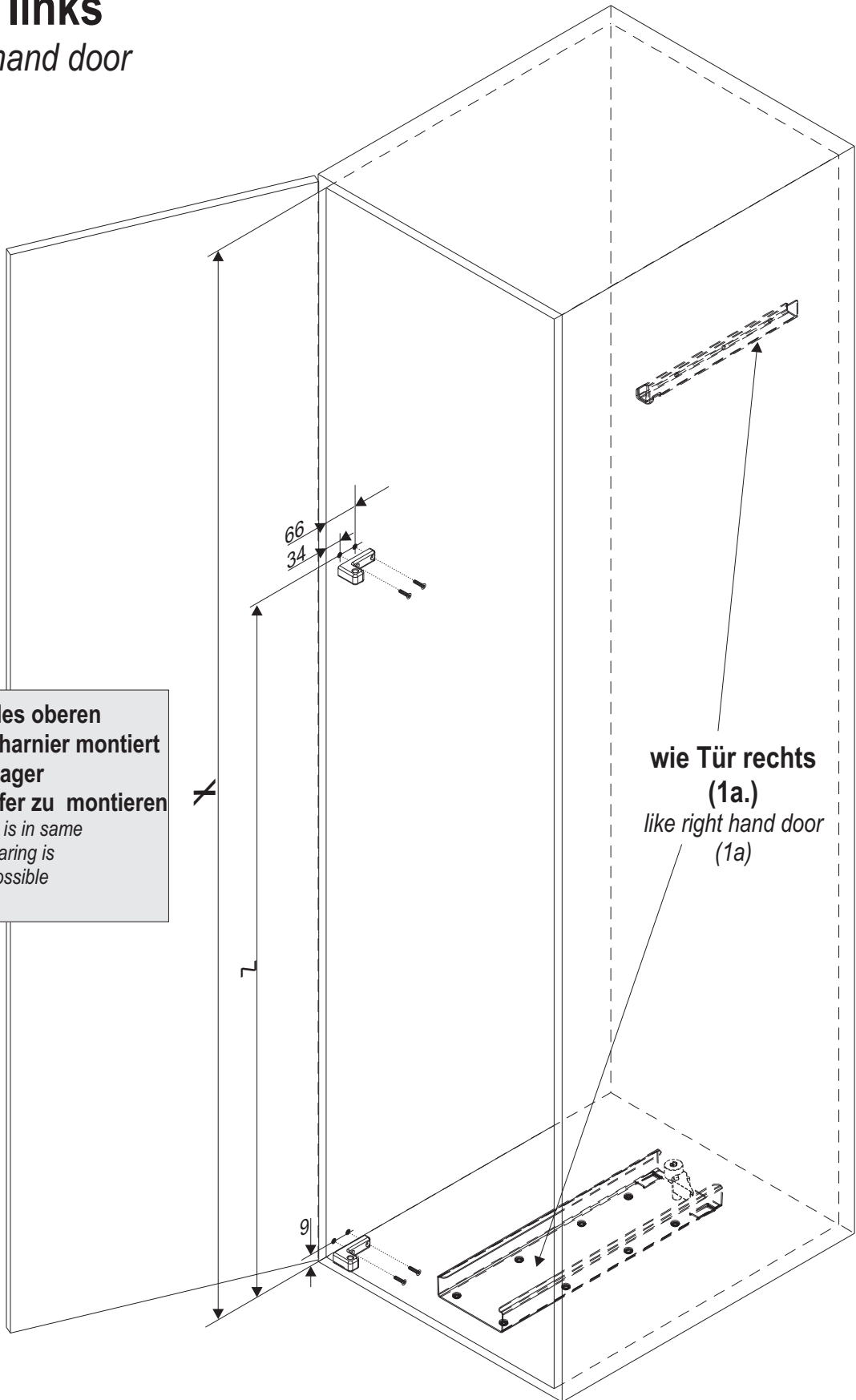
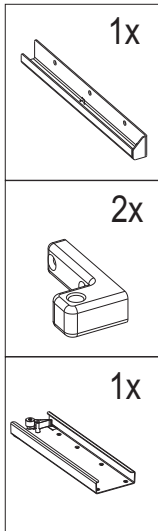

**Sollte auf Höhe des oberen
Lagers ein Türscharnier montiert
sein, so ist das Lager
entsprechend tiefer zu montieren**

*In case of top bearing is in same
hight as hinge, the bearing is
to move to the next possible
lower position*

X	Z
min. 1100	625
min. 1700	1225

2. Tür links / rechts

left/right hand door

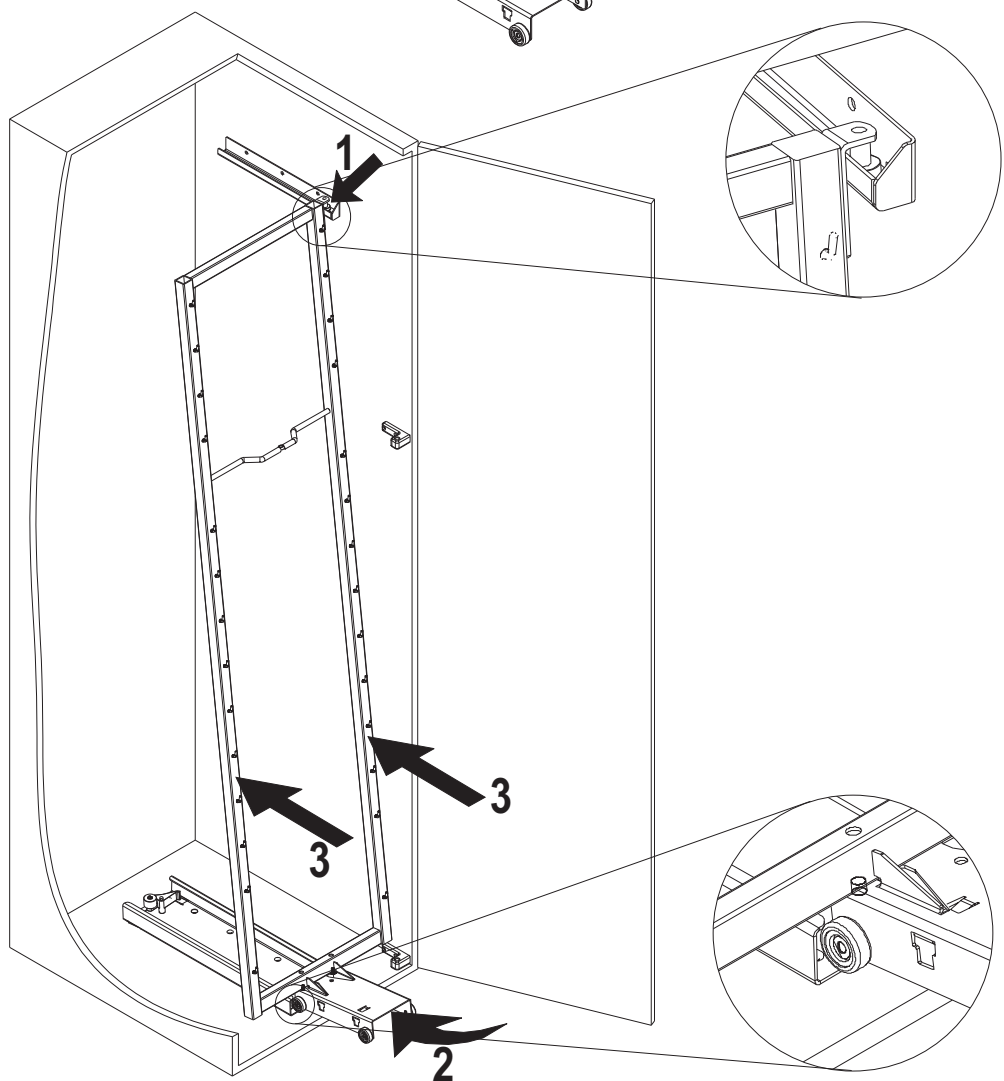
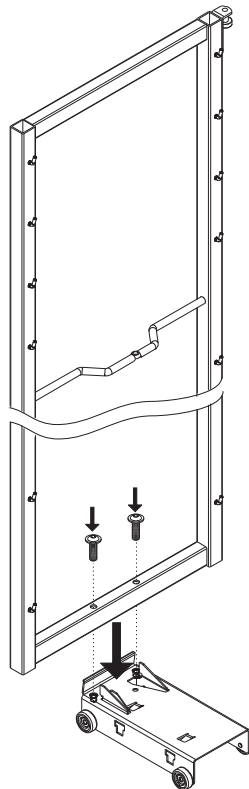
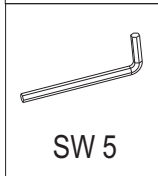
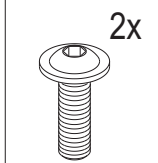
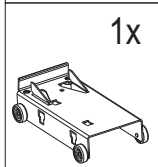
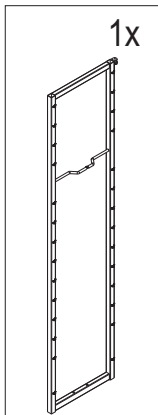

3.

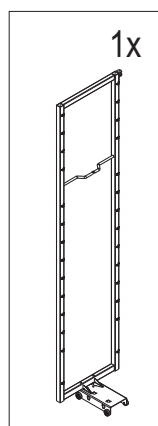

4a. Tür rechts *right hand door*

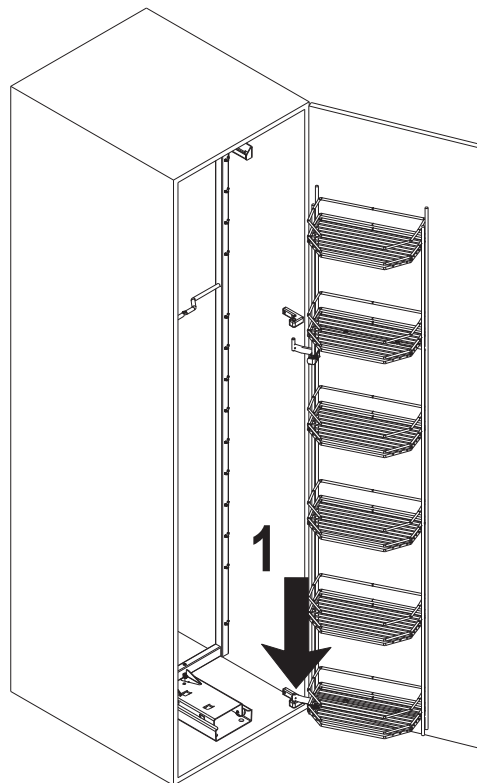
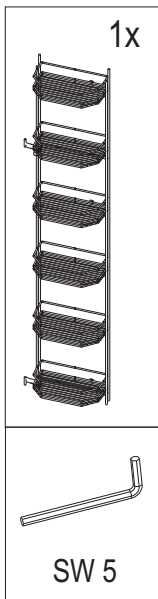

1 Türregal in unteres Lager einsetzen
Insert door shelf into bottom bearing

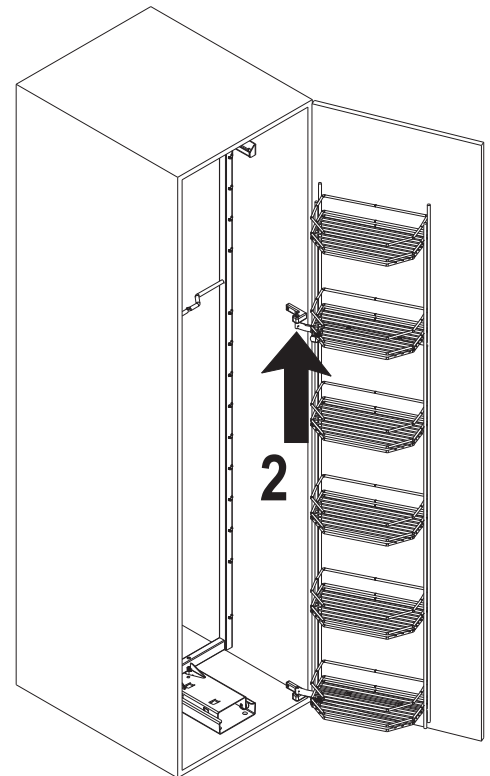

2 Obere Türanbindung lösen, einschieben und festschrauben
Loosen top door connection insert into the bearing and screw tight

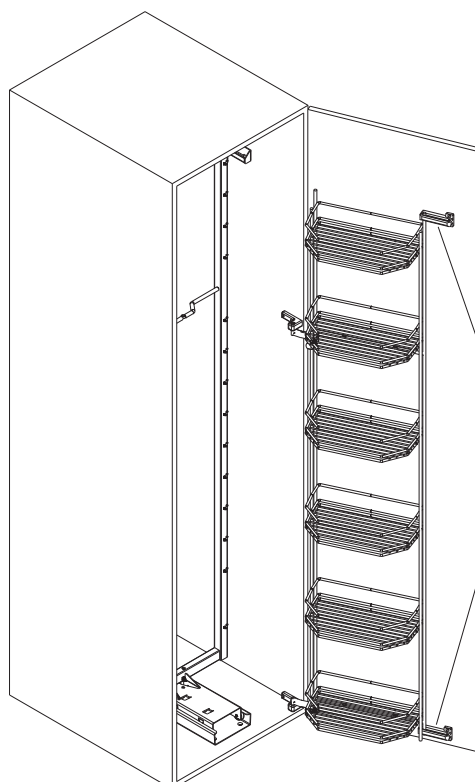
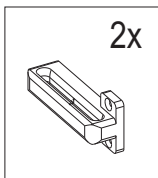

3 Türregal bis Anschlag öffnen, Mitnehmer oben und unten auf Türregal aufsetzen, Position je nach Türscharnier ermitteln und anschrauben
open door shelf to the very end, put top- and bottom follower onto doorshelf. Depending on used door hinge, find ideal position for follower and screw tight

5a. Tür rechts *right hand door*

2x

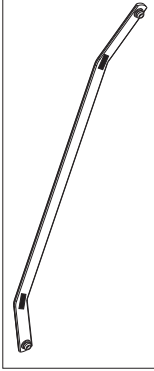

Oberen und unteren Mitnehmer
in Türregal und Auszugsrahmen
einklipsen
*Clip upper- and bottom follower
into door shelf and pull-out frame*

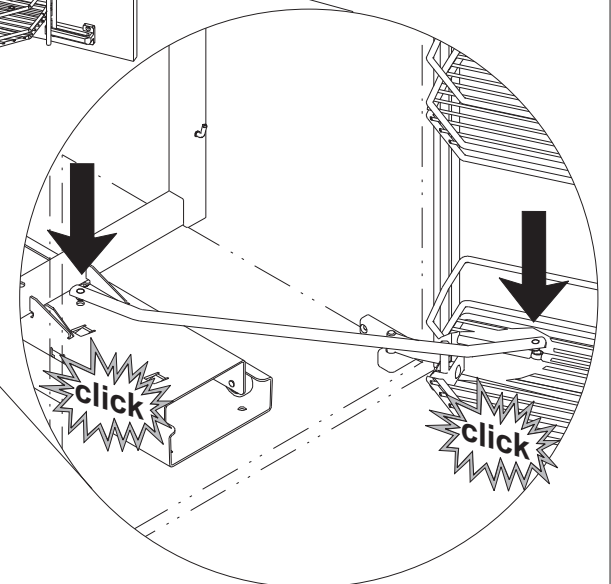
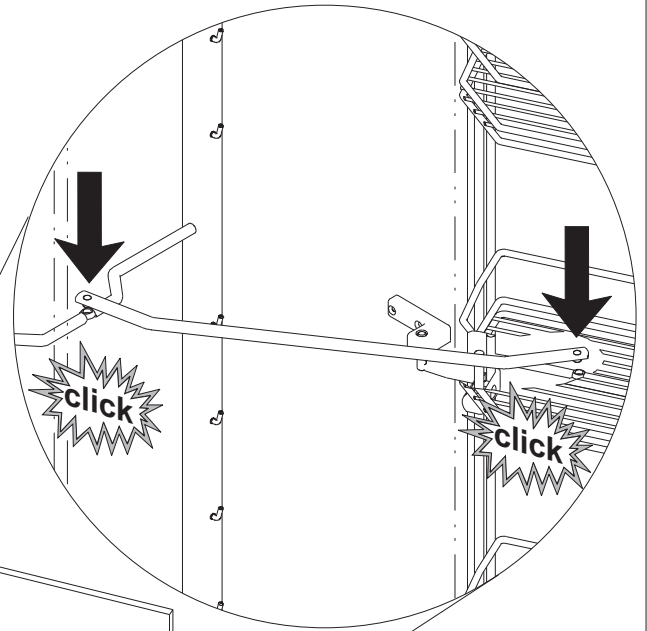
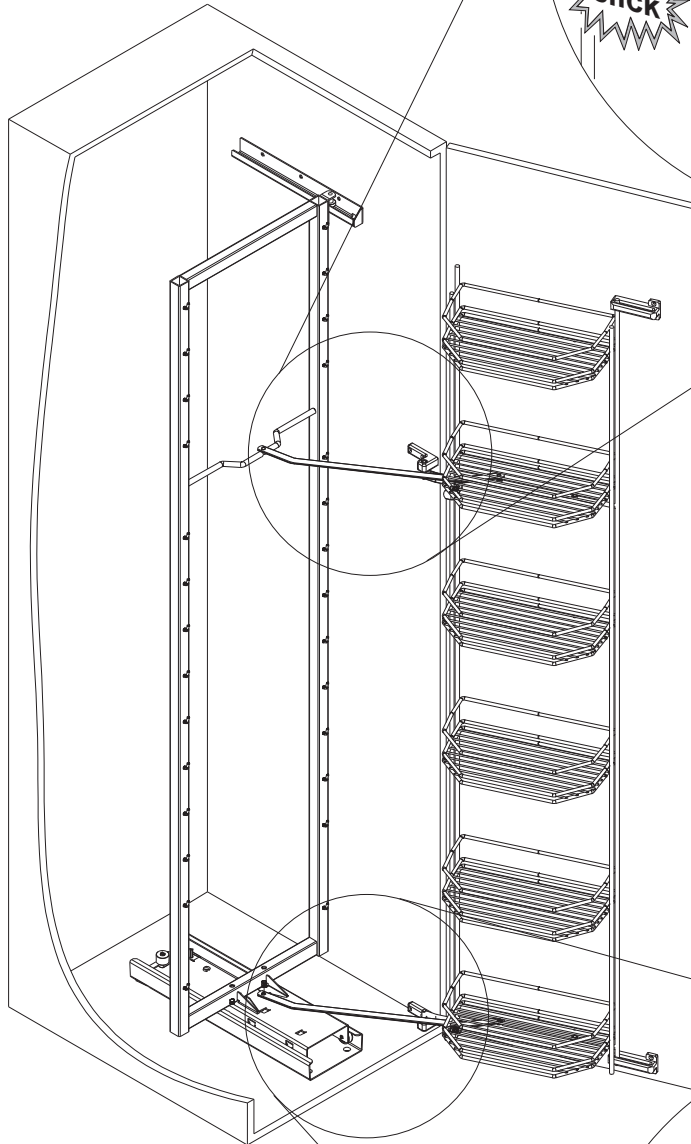

4b. Tür links

left hand door

Tür rechts
(Lieferzustand)

right hand door
(how we deliver)

Tür links

left hand door

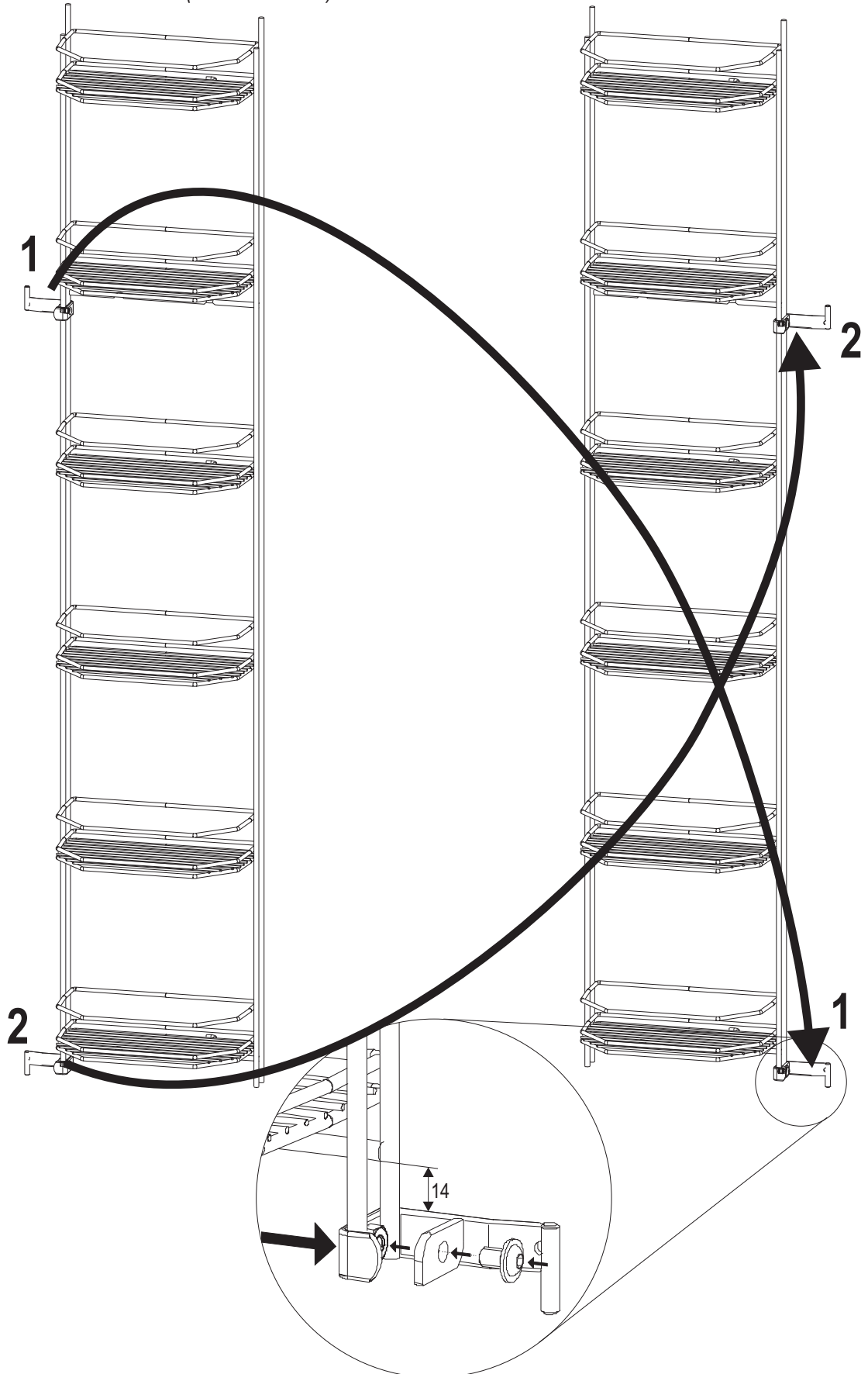
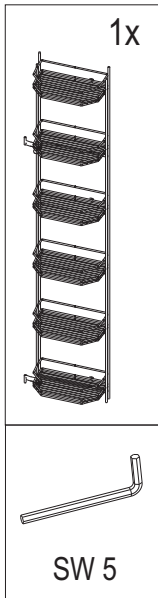

4b / 5b. Tür links

left hand door

**Die Montage Tür links ist entsprechend
spiegelbildlich wie die Montagepunkte
4a und 5a (Tür rechts) auszuführen**

*The installation for the left hand door is
a mirror image to as shown in 4a and 5a
(right hand door)*

